

# Datasheet

Product type: **Frequency converter**  
 Product ID: 155188  
 Product name: FU 22 33

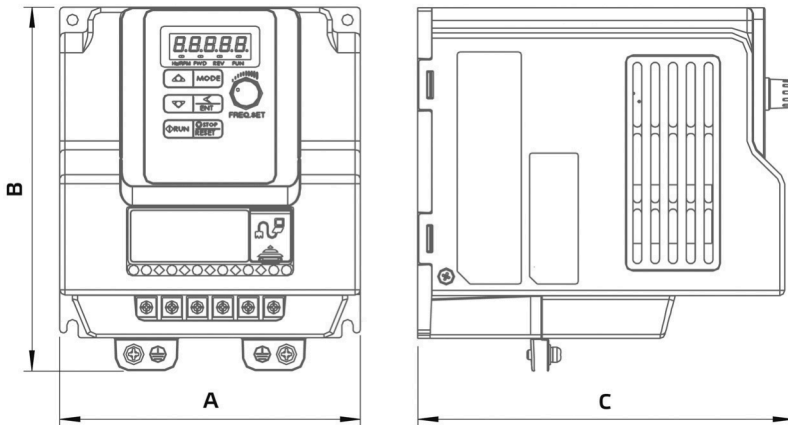

A	mm	118
B	mm	144
C	mm	150
D	mm	108
E	mm	121
Min. ambient temperature	°C	-10
Max. ambient temperature	°C	40
Max. operating current	A	5.2
Supply voltage	V	400V 3~ 50/60Hz
System protection		IP20
max. Rated operating capacity	kW	2.2
Weight	kg	1.5

- Output voltage 0 - 400 V 3~
- Stepless speed control
- Motor-/converter protection
- Integrated interference filter/class A
- Integrated Modbus or BacNet interface
- Configurable status/fault relay
- Easy start-up

Use:  
 · AL 710 D6 01

Wiring diagram:

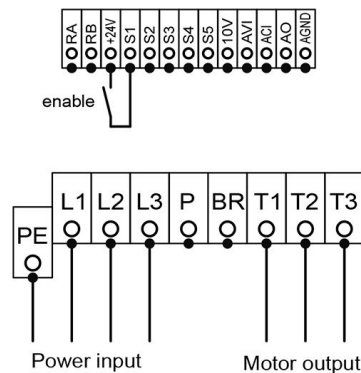

Assembly:

